

*caligri*<sup>®</sup>

# AIRTUBE

## MANUAL

**ENGLISH**

**DEUTSCH**

**FRANÇAIS**

**ESPAÑOL**

**ITALIANO**

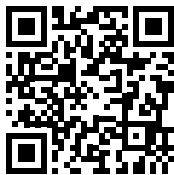

**FAQ & VIDEO**

**SUPPORT.CALIGRI.COM**

## INDEX

- **PACKAGE CONTENTS**
- **USAGE EXAMPLE**
- **AIRTUBE DIAGRAM**
- **INTENDED USE**
- **MAINTENANCE**
- **SAFETY INSTRUCTIONS**
- **INSTALLATION**
- **ADDITIONAL ACCESSORIES**

## TIP

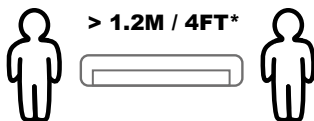

**\*WE RECOMMEND SETTING UP  
THE AIRTUBE WITH TWO PEOPLE**

**PACKAGE CONTENTS**

**EN**

**BAG**



**MANUAL**

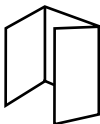

**AIRTUBE**



**VELCRO**

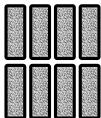

**SLEEVE**



**CARDBOARD  
TUBE**



**SPILL LIGHT COVER**

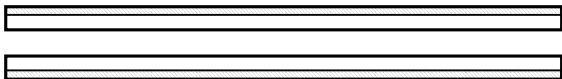

**2X SKIRT**



## USAGE EXAMPLE

**LED TUBE**  
FOR EXAMPLE, ASTERA

**VELCRO**  
**STRAP**

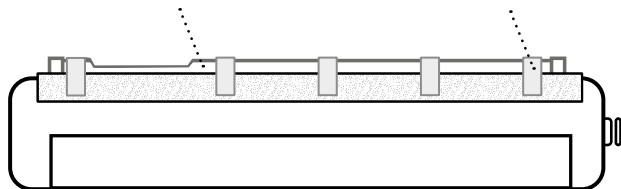

## TIP

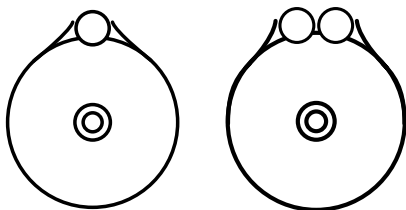

**A LARGE VARIETY OF LED TUBES CAN BE  
USED AS SINGLE OR DOUBLE FIXTURE**



## LOOPS

MAX 4 KG / 9 LBS  
PER SIDE

ULTRABOUNCE®

FOLDING  
SEAM

OPENING

MAGIC CLOTH®

VELCRO  
BAND

VALVE

SMALL RING: INFLATE  
LARGE RING: DEFLATE



MAX . AMBIENT TEMPERATURE  
MAX . SURFACE TEMPERATURE

+45°C / 113°F  
+85°C / 185°F

## **INTENDED USE**

**THIS PRODUCT IS AN ACCESSORY FOR MANY TYPES AND SIZES OF LED TUBES USED IN THE PROFESSIONAL FILM AND TV INDUSTRY.**

**THE PRODUCT IS MOUNTED IN FRONT OF LED TUBE(S) AND INFLATED IN ORDER TO ENLARGE THE LIGHT APERTURE. OTHER CALIGRI® ACCESSORIES CAN BE ATTACHED TO IT SECURELY.**

**ALWAYS FOLLOW THE SAFETY INFORMATION.**

**ANY USAGE OTHER THAN DESCRIBED ABOVE CAN DAMAGE THE PRODUCT.**

**DO NOT MODIFY THE PRODUCT.**

## **MAINTENANCE**

**INSPECT THE PRODUCT REGULARLY FOR VISIBLE DAMAGE.**

**DO NOT USE A PRODUCT WITH A DEFECTIVE COMPONENT.**

**ALWAYS USE THE PROTECTIVE SLEEVE AND CARDBOARD ROLL.**

**BEFORE FIRST USE, PLEASE READ ALL INSTRUCTIONS PROVIDED WITH THE PRODUCT. THE INSTRUCTIONS CONTAIN IMPORTANT INFORMATION FOR SAFE HANDLING.**

**PLEASE KEEP ALL INSTRUCTIONS PROVIDED WITH THE PRODUCT FOR POSSIBLE SUBSEQUENT OWNERS. THE USER MUST BE QUALIFIED FOR THE APPROPRIATE USE OF THE PRODUCT.**

**USE THE PRODUCT IN ACCORDANCE WITH REGULATIONS.**

**ATTACH YOUR SAFETY CABLE TO A LOOP OF THE AIRTUBE. ATTACH YOUR LIGHT FIXTURE IN ACCORDANCE TO THE LIGHT FIXTURE INSTRUCTION.**

**DO NOT USE AGGRESSIVE CLEANING AGENTS.**

**BE AWARE OF INCREASED HEATING OF YOUR LIGHT FIXTURE WHILE BEING OPERATED WITH AN AIRTUBE.**

**CALIGRI® GMBH IS NOT LIABLE FOR DAMAGE CAUSED BY IMPROPER USE OR INCORRECT OPERATION OF THE PRODUCT.**

## **1 UNROLL**

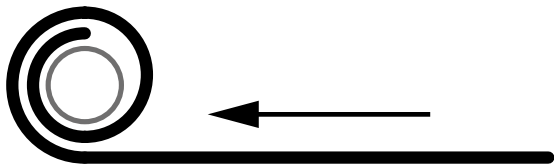

**UNROLL THE AIRTUBE FROM  
THE CARDBOARD ROLL**

**REMOVE THE PROTECTIVE SLEEVE  
AND PLACE THE AIRTUBE ON IT**

## **2 PREPARATION**

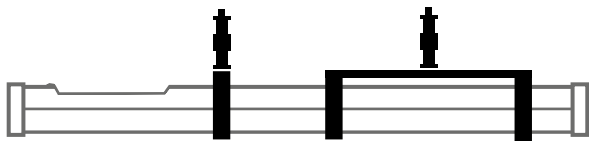

**IF NECESSARY, ATTACH YOUR  
LED TUBE MOUNTINGS FIRST**



### 3 LED MOUNTING

EN

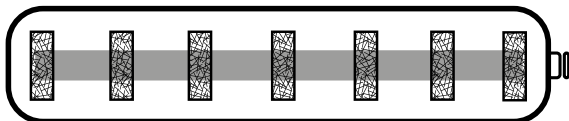

**PLACE THE LED TUBE(S) ON THE DEFLATED AIRTUBE OR ATTACH IT TO PRE-RIGGED LED LIGHT FIXTURES AND FASTEN IT WITH THE PROVIDED VELCRO STRAPS**

### 4 INFLATION

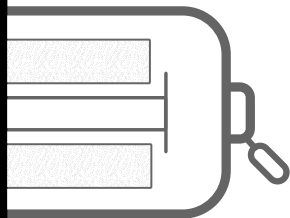

**MAX. 0,05 BAR / 0,72 PSI**

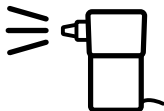

**OPEN THE SMALLER RING AND INFLATE THE AIRTUBE SLOWLY**

**KEEP AIR PRESSURE IN MIND WHEN USING AN AIR PUMP**

## 5 DEFLATION AND WRAPPING

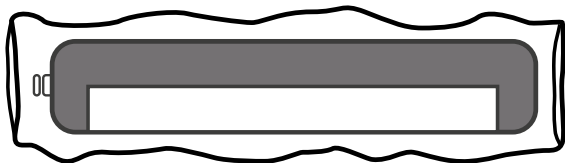

**REMOVE THE LED FIXTURE(S) AND PLACE  
THE STILL INFLATED AIRTUBE INTO THE  
PROTECTIVE SLEEVE**

**OPEN THE VALVE BY OPENING  
THE LARGER OF THE TWO RINGS**

**DO NOT FORCE THE DEFLATION PROCESS**

**FOLD THE AIRTUBE ONLY ALONG  
THE FOLDING SEAM TO PREVENT  
DIRT AND CREASES**

**SPILL LIGHT CAN BE AVOIDED WITH  
THIS COVER, BUT BE AWARE OF  
INCREASED HEAT**



**ATTACH EITHER ONE OR BOTH  
SKIRTS TO THE LOWER PART OF  
THE VELCRO BAND**

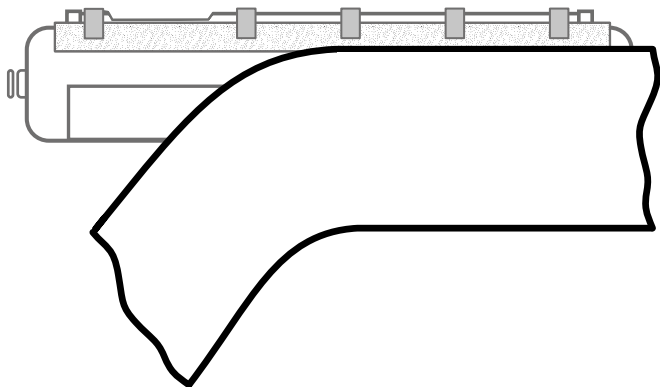

## INDEX

- **VERPACKUNGSINHALT**
- **ANWENDUNGSBEISPIEL**
- **AIRTUBE ZEICHNUNG**
- **BESTIMMUNGSGEMÄSSE VERWENDUNG**
- **WARTUNG**
- **SICHERHEITSHINWEISE**
- **INSTALLATION**
- **ZUBEHÖR**

## TIP

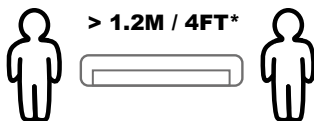

**\*WIR EMPFEHLEN, DIE AIRTUBE  
MIT ZWEI PERSONEN ZU MONTIEREN**

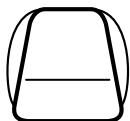
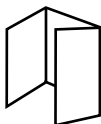
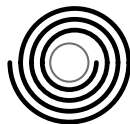
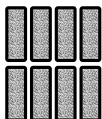
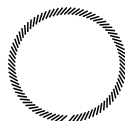
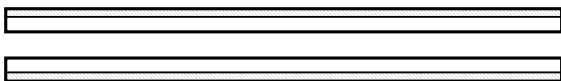
**TASCHE****ANLEITUNG****AIRTUBE****KLETT-  
STREIFEN****SCHUTZHÜLLE****PAPPROLLE****SCHMUTZLICHT ABDECKUNG****2X SCHÜRZE**

## VERWENDUNGSBEISPIEL

**LED RÖHRE  
ZUM BEISPIEL ASTERA**

**KLETT-  
STREIFEN**

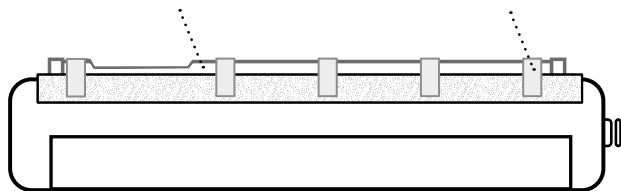

## TIP

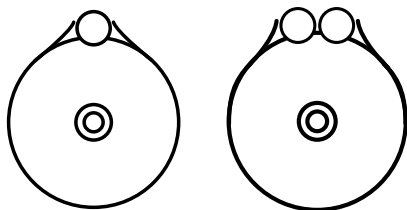

**EINE VIELZAHL VON LED RÖHREN  
KÖNNEN ENTWEDER EIN- ODER  
MEHRREIHIG VERWENDET WERDEN.**



**SCHLAUFEN**

**MAX 4 KG / 9 LBS  
PRO SEITE**

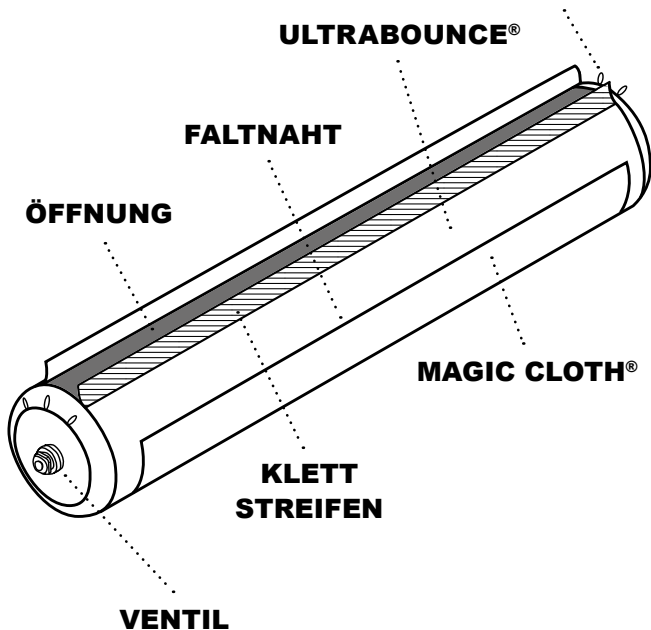

**KLEINER RING: AUFBLASEN  
GROSSER RING: ENTLÜFTEN**



**MAX . UMGEBUNGSTEMPERATUR  
MAX . OBERFLÄCHENTEMPERATUR**

**+45°C / 113°F  
+85°C / 185°F**

## **BESTIMMUNGSGEMÄSSE VERWENDUNG**

**DAS PRODUKT IST EIN ZUBEHÖR FÜR VIELE ARTEN UND GRÖSSEN VON LED RÖHREN AUS DER PROFESSIONELLEN FILM UND TV INDUSTRIE.**

**DAS PRODUKT WIRD VOR DIE LED LEUCHE(N) MONTIERT UND AUFGEBLASEN UM DIE LEUCHTFLÄCHE ZU VERGRÖSSERN. WEITERE CALIGRI® ZUBEHÖRARTIKEL KÖNNEN SICHER DARAN BEFESTIGT WERDEN.**

**BEFOLGEN SIE IMMER DIE SICHERHEITSHINWEISE.**

**EINE ANDERE ALS DIE BESCHRIEBENE VERWENDUNG KANN ZUR BESCHÄDIGUNG DIESES PRODUKTES FÜHREN.**

**ÄNDERN ODER MODIFIZIEREN SIE NICHT DAS PRODUKT.**

## **WARTUNG**

**PRÜFEN SIE DAS PRODUKT REGELMÄSSIG AUF SICHTBARE SCHÄDEN.**

**VERWENDEN SIE KEIN PRODUKT, DAS EINE DEFEKTE KOMPONENTE AUFWEIST.**

**VERWENDEN SIE IMMER DIE SCHUTZHÜLLE UND PAPPROLLE.**



**BITTE LESEN SIE DIESE UND ALLE MIT DEM PRODUKT GELIEFERTEN ANLEITUNGEN VOR DER ERSTEN VERWENDUNG. SIE ENTHALTEN WICHTIGE HINWEISE FÜR DIE SICHERE HANDHABUNG.**

**BEWAHREN SIE ALLE MIT DEM PRODUKT GELIEFERTEN ANLEITUNGEN FÜR EVENTUELLE NACHBESITZER SORGFÄLTIG AUF. DER ANWENDER MUSS FÜR DIE VERWENDUNG DES PRODUKTES QUALIFIZIERT SEIN.**

**VERWENDEN SIE DAS PRODUKT BESTIMMUNGSGEMÄSS.**

**BEFESTIGEN SIE IHR SICHERUNGSSEIL AN EINER SCHLAUFE DER AIRTUBE. SICHERN SIE ZUSÄTZLICH IHRE LEUCHE(N) ENTSPRECHEND DER LEUCHTENANWEISUNG.**

**VERWENDEN SIE KEINE AGGRESSIVEN REINIGUNGSMITTEL.**

**BEACHTEN SIE DIE ERHÖHTE ERWÄRMUNG IHRER LEUCHE WÄHREND DES BETRIEBS MIT EINER AIRTUBE.**

**DIE CALIGRI® GMBH HAFTET NICHT FÜR SCHÄDEN DURCH NICHT BESTIMMUNGSGEMÄSSE VERWENDUNGEN ODER FALSCH E BEDIENUNG.**

## **1 AUSROLLEN**

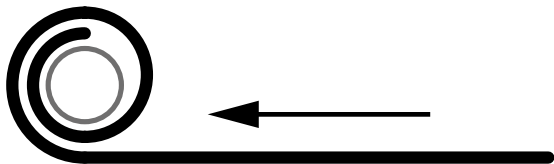

**ROLLEN SIE DIE AIRTUBE  
VON DER PAPPROLLE AB**

**ENTFERNEN SIE DIE SCHUTZHÜLLE UND  
LEGEN SIE DIE AIRTUBE AUF DIESER AB**

## **2 VORBEREITUNG**

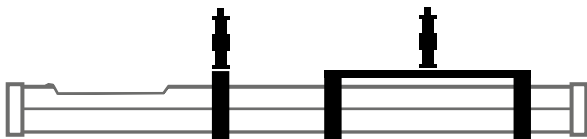

**BEI BEDARF MONTIEREN SIE ZUERST  
IHRE LED-RÖHREN BEFESTIGUNGEN**

### 3 LED-MONTAGE

DE

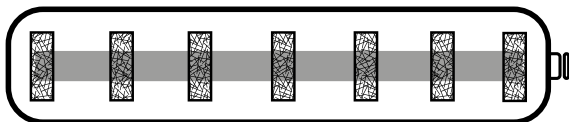

**MITTELS DER KLETTBÄNDER  
BEFESTIGEN SIE DIE LED RÖHRE(N)  
AUF EINER ENTLÜFTETEN AIRTUBE ODER AN  
BEREITS HÄNGENDEN LED LEUCHTEN**

### 4 AUFBLASEN

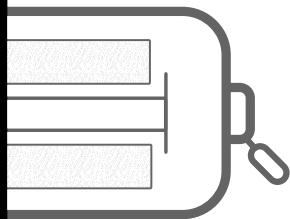

**MAX. 0,05 BAR / 0,72 PSI**

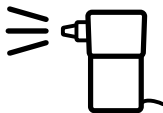

**ÖFFNEN SIE DEN KLEINEN RING UND  
BLASEN SIE DIE AIRTUBE LANGSAM AUF**

**BEACHTEN SIE DEN LUFTDRUCK, WENN  
SIE EINE LUFTPUMPE VERWENDEN**

## 5 ENTLÜFTEN UND VERPACKEN



**ENTFERNEN SIE DIE LED-LEUCHTEN UND  
LEGEN SIE DIE NOCH AUFGEBLASENE  
AIRTUBE IN DIE SCHUTZHÜLLE**

**ÖFFNEN SIE DAS VENTIL DURCH  
AUFSCHRAUBEN DES GRÖßEREN RINGES**

**ÜBEN SIE KEINEN HOHEN  
DRUCK BEIM ENTLÜFTEN AUS**

**UM SCHMUTZ UND KNICKE ZU  
VERMEIDEN, ROLLEN SIE DIE AIRTUBE  
NUR ENTLANG DER FALTNAHT AUF**

**DURCH DIESE ABDECKUNG KÖNNEN  
SIE SCHMUTZLICHT VERMEIDEN**

**BEACHTEN SIE JEDOCH  
ERHÖHTE TEMPERATUREN**



**BEFESTIGEN SIE ENTWEDER EINE  
ODER BEIDE SCHÜRZEN AM UNTEREN  
TEIL DES KLETTBANDES**

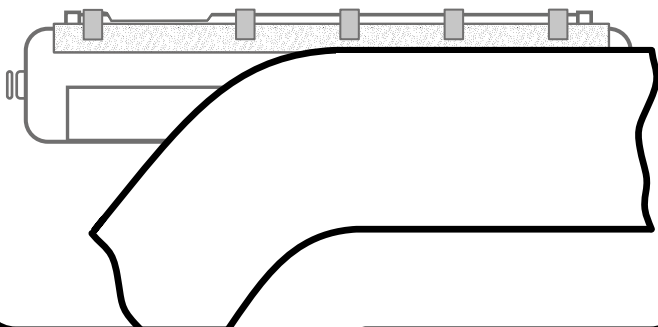

## **INDEX**

- **CONTENU DU PAQUET**
- **EXEMPLE D'UTILISATION**
- **SCHÉMA DE L'AIRTUBE**
- **UTILISATION PRÉVUE**
- **MAINTENANCE**
- **INSTRUCTIONS DE SÉCURITÉ**
- **INSTALLATION**
- **ACCESSOIRES SUPPLÉMENTAIRES**

## **CONSEIL**

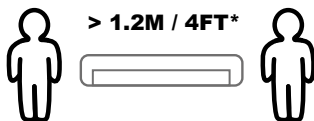

**\*NOUS RECOMMANDONS LA MISE  
EN PLACE DE L'AIRTUBE À DEUX  
PERSONNES**

**SAC**



**MODE D'EMPLOI**

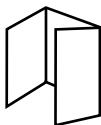

**AIRTUBE**

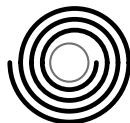

**VELCRO**

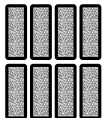

**MANCHON**



**TUBE EN  
CARTON**



**COUVERTURE DE LUMIÈRE  
DE DÉVERSEMENT**



**2X JUPE**



## EXEMPLE D'UTILISATION

**TUBE LED**  
**PAR EXEMPLE ASTERA**

**BANDE**  
**VELCRO**

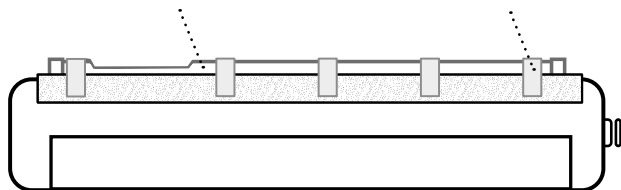

## CONSEIL

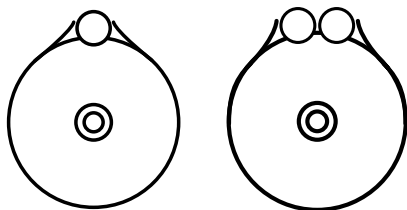

**UNE GRANDE VARIÉTÉ DE TUBES LED**  
**PEUT ÊTRE UTILISÉE COMME LUMINAIRE**  
**SIMPLE OU DOUBLE**





**BOUCLES**

**MAX 4 KG / 9 LBS  
PAR CÔTÉ**

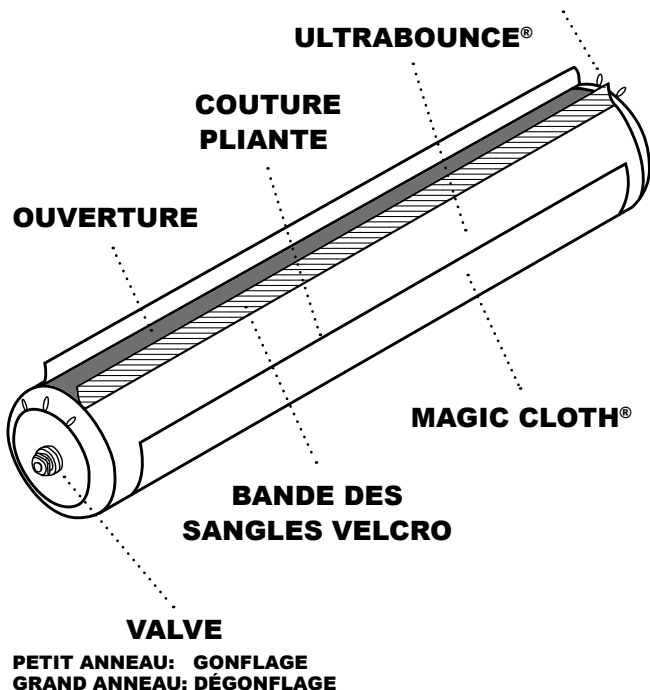

**TEMPÉRATURE MAX. AMBIANTE**  
**TEMPÉRATURE MAX. DE SURFACE**

**+45°C / 113°F**  
**+85°C / 185°F**

## **UTILISATION PRÉVUE**

**CE PRODUIT EST UN ACCESSOIRE POUR DES NOMBREUX TYPES ET TAILLES DE TUBES LED UTILISÉS DANS L'INDUSTRIE PROFESSIONNELLE DU FILM ET DE LA TÉLÉVISION.**

**LE PRODUIT EST MONTÉ DEVANT LE(S) TUBE(S) LED ET GONFLÉ AFIN D'AGRANDIR L'APERTURE LUMINEUSE.**

**D'AUTRES ACCESSOIRES CALIGRI® PEUVENT ÊTRE FIXÉS SOLIDEMENT AU PRODUIT.**

**SUIVEZ TOUJOURS L'INFORMATION DE SÉCURITÉ.**

**TOUTE UTILISATION AUTRE QUE CELLE DÉCRITE CI-DESSUS PEUT ENDOMMAGER LE PRODUIT.**

**NE MODIFIEZ PAS LE PRODUIT.**

## **MAINTENANCE**

**INSPECTEZ LE PRODUIT RÉGULIÈREMENT POUR DES DOMMAGES VISIBLES.**

**N'UTILISEZ PAS UN PRODUIT AVEC UN COMPOSANT DÉFECTUEUX.**

**UTILISEZ TOUJOURS LE MANCHON DE PROTECTION ET LE TUBE EN CARTON.**

**AVANT LA PREMIÈRE UTILISATION, VEUILLEZ LIRE TOUTES LES INSTRUCTIONS FOURNIES AVEC LE PRODUIT. LES INSTRUCTIONS CONTIENNENT DES INFORMATIONS IMPORTANTES POUR LE MANIEMENT SECURE DU PRODUIT.**

**VEUILLEZ CONSERVER TOUTES LES INSTRUCTIONS FOURNIES AVEC LE PRODUIT POUR LES ÉVENTUELS PROPRIÉTAIRES ULTÉRIEURS. L'UTILISATEUR DOIT ÊTRE QUALIFIÉ POUR L'UTILISATION APPROPRIÉE DU PRODUIT.**

**UTILISEZ LE PRODUIT CONFORMÉMENT AUX RÉGLEMENTATIONS.**

**FIXEZ VOTRE CÂBLE DE SÉCURITÉ À UNE BOUCLE DE L'AIRTUBE. FIXEZ VOTRE LUMINAIRE CONFORMÉMENT AUX INSTRUCTIONS DU LUMINAIRE.**

**N'UTILISEZ PAS D'AGENTS DE NETTOYAGE AGRESSIFS.**

**SOYEZ CONSCIENT DE L'AUGMENTATION DU CHAUFFAGE DE VOTRE LUMINAIRE TOUT EN ÉTANT UTILISÉ AVEC UN AIRTUBE.**

**CALIGRI® GMBH N'EST PAS RESPONSABLE DES DOMMAGES CAUSÉS PAR UNE MAUVAISE UTILISATION OU UN MAUVAIS MANIEMENT DU PRODUIT.**

## **1 DÉROULER**

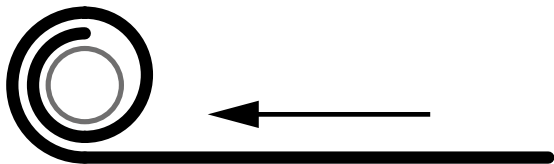

**DEROULEZ L'AIRTUBE  
DU TUBE EN CARTON**

**RETIREZ LE MANCHON DE  
PROTECTION ET PLACEZ  
L'AIRTUBE DESSUS**

## **2 PRÉPARATION**

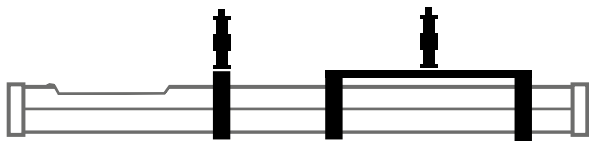

**SI NÉCESSAIRE, ATTACHEZ D'ABORD  
LES SUPPORTS DE VOTRE TUBE LED**

### 3 MONTAGE DES LED

FR

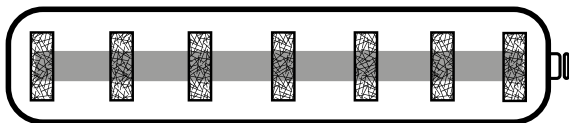

**PLACEZ LE(S) TUBE(S) LED SUR L'AIRTUBE DÉGONFLÉ OU ATTACHEZ-LE AVEC LES BOUCLES VELCRO FOURNIES SUR UNE LAMPE LED DÉJÀ MONTÉ**

### 4 GONFLAGE

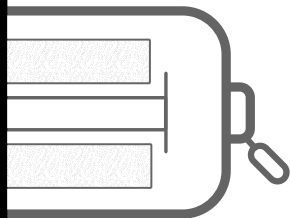

**MAX. 0,05 BAR / 0,72 PSI**

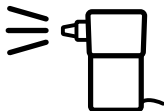

**OUVREZ LE PLUS PETIT ANNEAU ET GONFLEZ L'AIRTUBE LENTEMENT**

**GARDEZ LA PRESSION D'AIR À L'ESPRIT LORS DE L'UTILISATION D'UNE POMPE À AIR**

## 5 DÉGONFLAGE ET EMBALLAGE

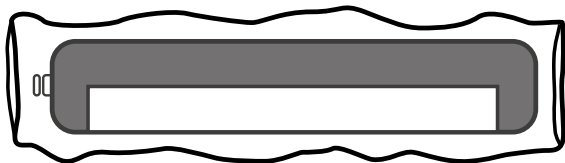

**RETIREZ LE(S) TUBE(S) LED ET PLACEZ  
L'AIRTUBE ENCORE GONFLÉ DANS LE  
MANCHON DE PROTECTION**

**OUVREZ LA VALVE PAR OUVERTURE  
DU PLUS GRAND DES DEUX ANNEAUX**

**NE FORCEZ PAS LE PROCESSUS  
DE DÉGONFLAGE**

**PLIEZ L'AIRTUBE UNIQUEMENT LE  
LONG DE LA COUTURE PLIANTE POUR  
PRÉVENIR LA SALETÉ ET DES PLIS**

**LE DÉVERSEMENT DE LA LUMIÈRE PEUT  
ÊTRE ÉVITÉE AVEC CETTE COUVERTURE,  
MAIS GARDEZ À L'ESPRIT L'AUGMENTATION  
DE LA CHALEUR**



**ATTACHEZ UNE OU LES DEUX JUPES À  
LA PARTIE INFÉRIEURE DE LA BANDE  
VELCRO**

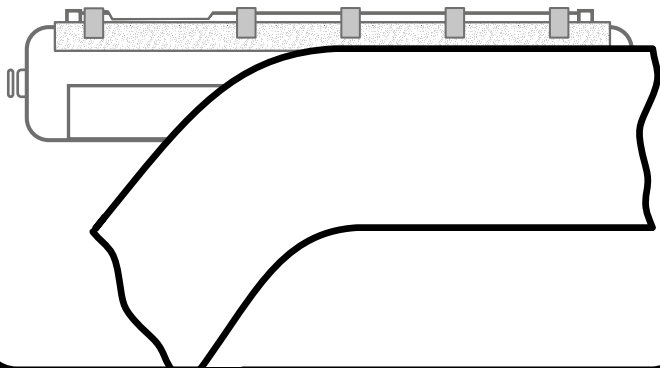

## **INDICE**

- **CONTENIDOS DEL PAQUETE**
- **EJEMPLO DE USO**
- **ESQUEMA AIRTUBE**
- **USO PREVISTO**
- **MANTENIMIENTO**
- **INSTRUCCIONES DE SEGURIDAD**
- **INSTALACIÓN**
- **ACCESORIOS ADICIONALES**

## **CONSEJO**

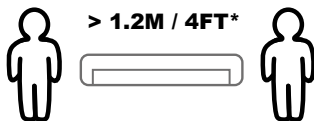

**\*RECOMENDAMOS INSTALAR EL  
AIRTUBE CON DOS PERSONAS**



# CONTENIDOS DEL PAQUETE

ES

**BOLSA**



**MANUAL**

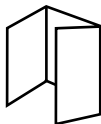

**AIRTUBE**



**VELCRO**

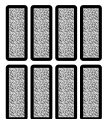

**MANGA  
PROTECTORA**



**TUBO DE  
CARTÓN**



**CUBIERTA PARA DERRAME DE LUZ**

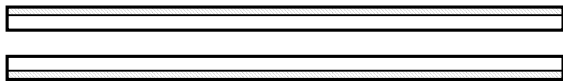

**2X JUPE**



## EJEMPLO DE USO

**TUBO LED  
POR EJEMPLO ASTERA**

**TIRA DE  
VELCRO**

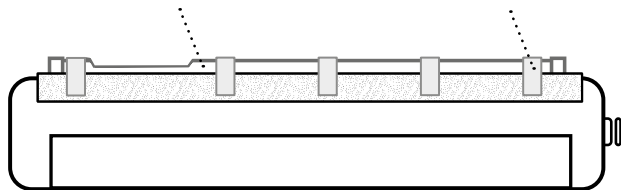

## CONSEJO

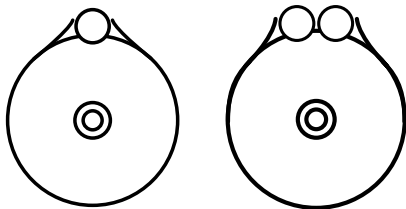

**SE PUEDE UTILIZAR UNA GRAN VARIEDAD DE  
TUBOS LED COMO LÁMPARA SIMPLE O DOBLE**



**LAZOS**

**MAX 4 KG / 9 LBS  
POR LADO**

**ULTRABOUNCE®**

**COSTURA  
PLEGABLE**

**APERTURA**

**MAGIC CLOTH®**

**CINTA DE VELCRO**

**VÁLVULA**

**ANILLO PEQUEÑO: INFLAR**

**ANILLO GRANDE: DESINFLAR**



**TEMPERATURA AMBIENTE MÁXIMA**

**+45°C / 113°F**

**TEMPERATURA MÁX. DE LA SUPERFICIE**

**+85°C / 185°F**

## **USO PREVISTO**

**ESTE PRODUCTO ES UN ACCESORIO PARA UNA GRAN VARIEDAD DE TIPOS Y TAMAÑOS DE TUBOS LED UTILIZADOS EN LA INDUSTRIA PROFESIONAL DEL CINE Y LA TELEVISIÓN.**

**EL PRODUCTO SE MONTA DELANTE DE LOS TUBOS LED Y SE INFLA PARA AMPLIAR LA APERTURA DE LA LUZ. OTROS ACCESORIOS CALIGRI® SE PUEDEN MONTAR DE FORMA SEGURA AL MISMO.**

**SIEMPRE SIGA LA INFORMACIÓN DE SEGURIDAD.**

**CUALQUIER USO DIFERENTE AL DESCRITO ANTERIORMENTE PUEDE DAÑAR EL PRODUCTO.**

**NO MODIFIQUE EL PRODUCTO.**

## **MANTENIMIENTO**

**INSPECCIONE EL PRODUCTO CON REGULARIDAD POR DAÑOS VISIBLES.**

**NO USE UN PRODUCTO CON UN COMPONENTE DEFECTUOSO.**

**UTILICE SIEMPRE LA MANGA PROTECTORA Y EL TUBO DE CARTÓN.**

**ANTES DEL PRIMER USO, LEA TODAS LAS INSTRUCCIONES SUMINISTRADAS CON EL PRODUCTO. LAS INSTRUCCIONES CONTIENEN INFORMACIÓN IMPORTANTE PARA UN MANEJO SEGURO.**

**CONSERVE TODAS LAS INSTRUCCIONES SUMINISTRADAS CON EL PRODUCTO PARA POSIBLES PROPIETARIOS POSTERIORES. EL USUARIO DEBE ESTAR CUALIFICADO PARA EL USO APROPIADO DEL PRODUCTO.**

**UTILICE EL PRODUCTO DE ACUERDO CON LAS NORMAS.**

**CONECTE SU CABLE DE SEGURIDAD A UN LAZO DEL AIRTUBE. COLOQUE SU LÁMPARA DE ACUERDO CON LAS INSTRUCCIONES DE LA MISMA.**

**NO USAR AGENTES DE LIMPIEZA AGRESIVOS.**

**TENGA EN CUENTA EL MAYOR CALENTAMIENTO DE SU LÁMPARA MIENTRAS ESTÁ OPERADA CON UN AIRTUBE.**

**CALIGRI® GMBH NO SE HACE RESPONSABLE DE LOS DAÑOS CAUSADOS POR EL USO INCORRECTO O LA OPERACIÓN INCORRECTA DEL PRODUCTO.**

## **1 DESEENROLLAR**

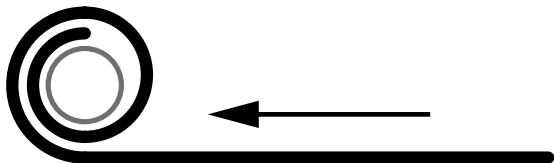

**DESEENROLLE EL AIRTUBE  
DEL TUBO DE CARTÓN**

**RETIRE LA MANGA PROTECTORA  
Y COLOQUE EL TUBO DE AIRE  
ENCIMA DE LA MANGA**

## **2 PREPARACIÓN**

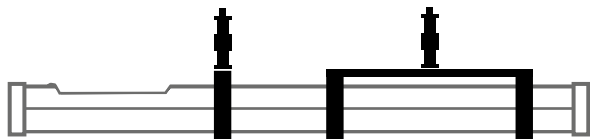

**SI ES NECESARIO, COLOQUE SUS  
MONTAJES DE TUBO LED PRIMERO**

### 3 MONTAJE LED

ES

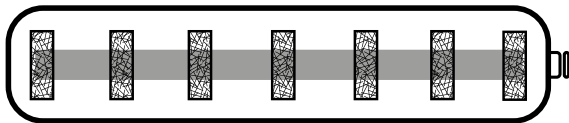

**COLOCA EL/LOS TUBO(S) LED EN EL AIRTUBE DESINFLADO O ASEGURE EL AIRTUBE CON LAS TIRAS DE VELCRO SUMINISTRADAS A LUCES LED YA MONTADAS**

### 4 INFLAR

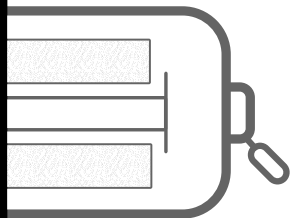

**MAX. 0,05 BAR / 0,72 PSI**

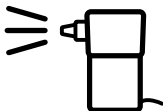

**ABRA EL ANILLO MÁS PEQUEÑO E INFLE EL AIRTUBE LENTAMENTE**

**TENGA EN CUENTA LA PRESIÓN DE AIRE AL UTILIZAR UNA BOMBA DE AIRE**

## 5 DESINFLAR Y EMBALAJE

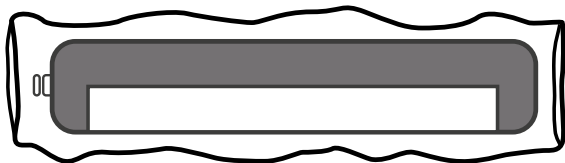

**RETIRE LOS TUBOS LED Y COLOQUE EL  
AIRTUBE AÚN INFLADO EN LA MANGA  
DE PROTECCIÓN**

**ABRA LA VÁLVULA ABRIENDO EL MÁS  
GRANDE DE LOS DOS ANILLOS**

**NO FORZAR EL PROCESO DE DEFLACIÓN**

**PLEGAR EL AIRTUBE SOLAMENTE A LO  
LARGO DE LA COSTURA PLEGABLE PARA  
EVITAR SUCIEDAD Y ARRUGAS**



**LOS DERRAMES DE LUZ SE PUEDEN EVITAR  
CON ESTA CUBIERTA, PERO TENGA EN  
CUENTA EL AUMENTO DE CALOR**



**COLOQUE UNA O AMBAS FALDAS A LA  
PARTE INFERIOR DE LA CINTA DE VELCRO**

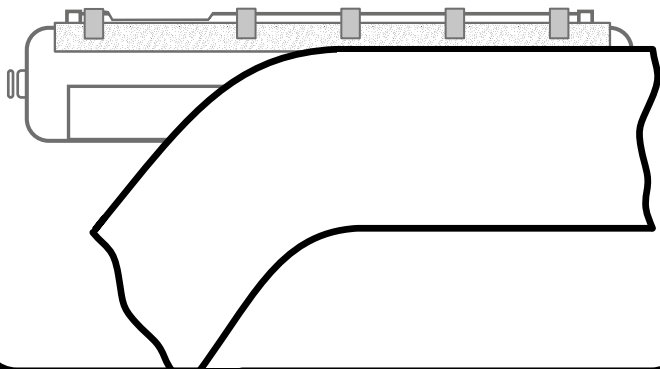

## **INDICE**

- **CONTENUTO DEL PACCO**
- **ESEMPIO DI APPLICAZIONE**
- **DISEGNO DELL`AIRTUBE**
- **USO PREVISTO**
- **MANUTENZIONE**
- **NOTA DI SICUREZZA**
- **MONTAGGIO**
- **ACCESSORI**

## **CONSIGLI UTILI**

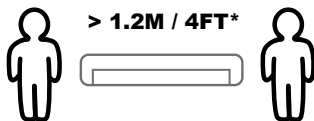

**\*SI CONSIGLIA DI MONTARE  
L`AIRTUBE CON DUE PERSONE**

**SACCHETTO**



**ISTRUZIONI  
D'USO**

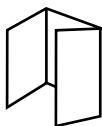

**AIRTUBE**



**FASCETTE A  
STRAPPO**

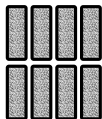

**COVER  
PROTETTIVA**



**ROTOLO DI  
CARTONE**



**COPERTURA PARALUCE SUPERIORE**



**2 X GREMBIULI PARALUCE LATERALI**



## ESEMPIO DI APPLICAZIONE

**TUBO LED**  
PER ESEMPIO ASTERA  
TITAN O ALTRO

**FASCETTE A STRAPPO**

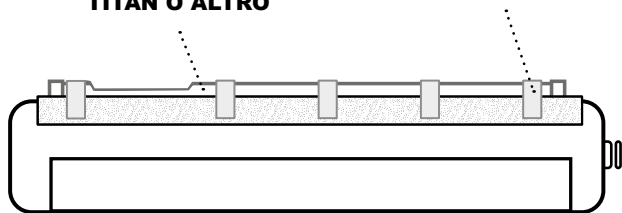

## CONSIGLI UTILI

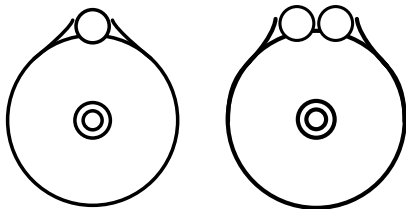

**SI POSSONO APPLICARE 1 O 2 TUBI LED  
SIA IN FILA SINGOLA CHE MULTIPLA**



**GANCIO**

**MAX 4 KG / 9 LBS  
PER LATO**

**ULTRABOUNCE®**

**PIEGA DI  
CUCITURA**

**APERTURA**

**MAGIC CLOTH®**

**FASCIETTE A  
STRAPPO**

**VALVOLA D'ARIA**

**ANELLO PICCOLO: GONFIARE  
ANELLO GRANDE: SGONFIARE**



**TEMPERATURA MASSIMA D'AMBIENTE  
TEMPERATURA MASSIMA SUPERFICE**

**+45°C / 113°F  
+85°C / 185°F**

## **PREDISPOSIZIONI D'USO**

**QUESTO PRODOTTO È UN ACCESSORIO ADATTO A DIVERSI TIPI DI TUBI LED NEL CAMPO PROFESSIONALE CINEMATOGRAFICO E TELEVISIVO.**

**IL PRODOTTO AIRTUBE VIENE GONFIATO E MONTATO PER AUMENTARE LA SUPERFICIA LUMINOSA DEI TUBI LED.**

**ULTERIORI ACCESSORI CALIGIRL® POSSONO ESSERE ASSEMBLATI E AMPLIATI.**

**SI CONSIGLIA DI SEGUIRE SEMPRE LE ISTRUZIONI DI SICUREZZA.**

**UN DIVERSO UTILIZZO DA QUANTO DESCRITTO, PUÓ CAUSARE DANNI.**

**NON MODIFICARE O CAMBIARE IL PRODOTTO.**

## **MANUTENZIONE**

**CONTROLLARE REGOLARMENTE IL PRODOTTO PER LA MANCANZA DI DANNI VISIBILI.**

**NON UTILIZZARE IL PRODOTTO NEL CASO FOSSE DANNEGGIATO E USARE SEMPRE LA BUSTA PROTETTIVA COME ANHE IL ROTOLO DI CARTONE.**

**SI PREGA DI LEGGERE LE ISTRUZIONI FORNITE PRIMA DELL'UTILIZZO DEL PRODOTTO PER LA PRIMA VOLTA. LE INDICAZIONI CONTENGONO IMPORTANTI CONSIGLI PER UNA SICURA APPLICAZIONE.**

**CONSERVARE CON ATTENZIONE TUTTE LE ISTRUZIONI NEL CASO IL PRODOTTO VENGA TRASMESSO AD ALTRI UTENTI.**

**PER UN CORRETTO UTILIZZO DEL PRODOTTO AIRTUBE, L'UTENTE DEVE ESSERE QUALIFICATO.**

**UTILIZZARE IL PRODOTTO SOLO NEL MODO INDICATO.**

**UTILIZZARE I GANCI DELL'AIRTUBE PER ALLACCIAMENTI DI SICUREZZA. USARE ANELLI O CORDE PER LA PROTEZIONE DEI TUBI LED.**

**SI CONSIGLIA IL NON UTILIZZO DI DETERGENTI DI PULIZIA AGGRESSIVE.**

**CONTROLLARE L'AUMENTO DELLA TEMPERATURE DURANTE L'USO DELL'AIRTUBE.**

**LA CALIGIRL® NON É RESPONSABILE PER I DANNI CAUSATI DA UN UTILIZZO IMPROPRIO O DI UNA APPLICAZIONE ERRATA.**

## **1 SROTOLARE**

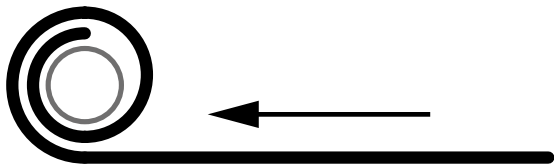

**ROLLARE L' AIRTUBE DAL  
ROTOLO DI CARTONE.**

**RIMUOVERE IL COVER PROTETTIVO  
DALL' AIRTUBE E STENDERLO SOPRA  
PER EVITARE LO SPORCO**

## **2 PREPARAZIONE**

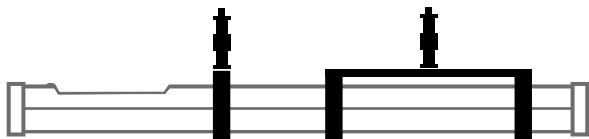

**SE NECESSARIO, APPLICARE PRIMA  
I TUBI LED NELLE APPOSITE TASCHE  
LATERALI.**



### 3 MONTAGGIO - LED

ITA



**CON L'AIUTO DELLE FASCE A STRAPPO, FISSARE IL/I TUBO/I LED SUL LATO SUPERIORE DELL' AIRTUBE SGONFIATO.**

### 4 GONFIARE

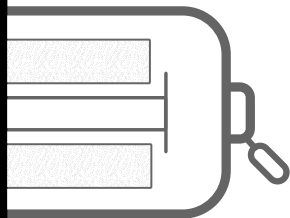

**MAX. 0,05 BAR / 0,72 PSI**

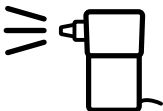

**APRIRE L'ANELLO PICCOLO E GONFIARE CON CAUTELA L'INTERNO DELL' AIRTUBE**

**CONTROLLARE LA PRESSIONE DELL'ARIA NEL CASO DI UTILIZZO DI UN COMPRESSORE D'ARIA.**

## 5 SFIATAMENTO E IMBALLAGGIO



**RIMUOVERE I/IL TUBO LED E INSERIRE  
L'AIRTUBE GONFIO NELLA COVER  
PROTETTIVA**

**APRIRE LA VALVOLA, SVITANDO  
L'ANELLO GRANDE**

**NON APPLICARE NESSUNA PRESSIONE  
FORZATA DURANTE IL PROCESSO DI  
SFIATAMENTO**

**PER EVITARE MACCHIE E DANNI VARI, SI  
CONSIGLIA DI ARROTOLARE L'AIRTUBE SOLO  
SUL LATO DELLA CUCITURA. LARGO DE LA  
COSTURA PLEGABLE PARA EVITAR SUCIEDAD  
Y ARRUGAS**

**CON QUESTO COPERTURA SI EVITA  
L'EMISSIONE DI LUCE SUPERFLUA  
CONTROLLARE ,L'AUMENTO DELLA  
TEMPERATURA**



**APPLICARE UNO O ENTRAMBI  
GREMBIULI PARALUCE SOTTO  
LE FASCETTE A STRAPPO**

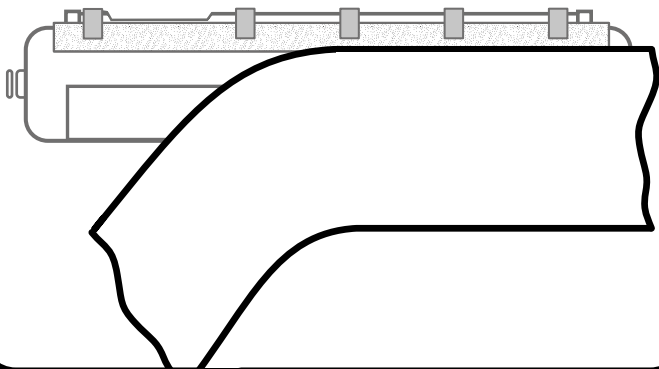



**FOLLOW US ON INSTAGRAM**

**CALIGRI GMBH  
VENLOER STR. 247  
50823 KÖLN  
GERMANY**

**VER 1.2 / 26.10.2021**